

PRACTICABLE DOMO 77RT

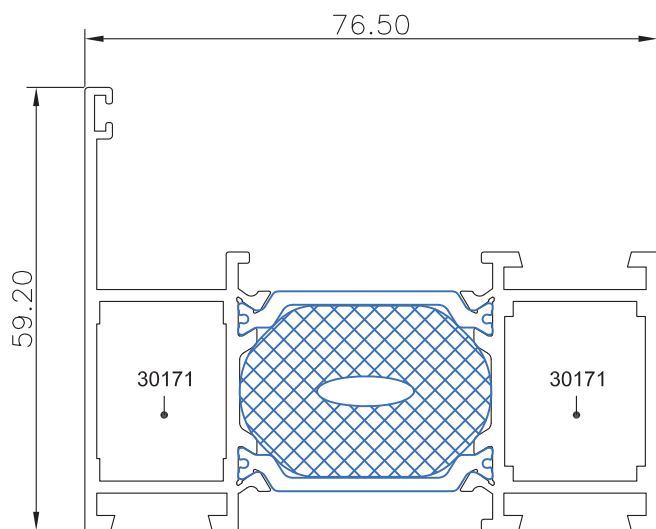

Ref. 2501

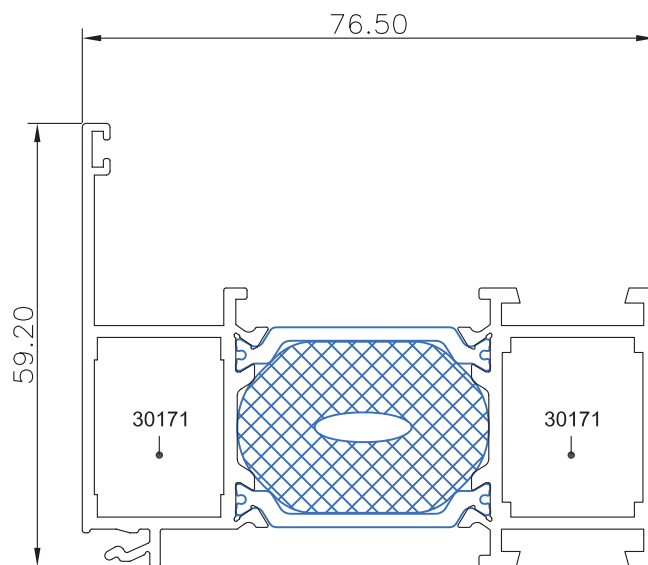

Ref. 2523

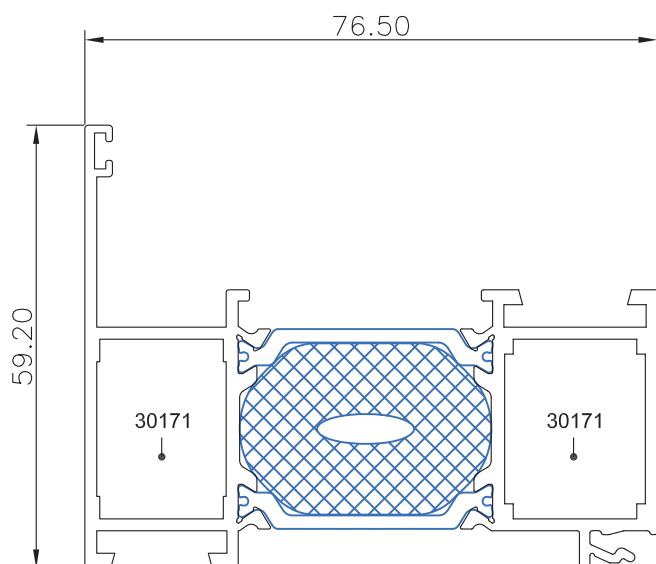

Ref. 2525

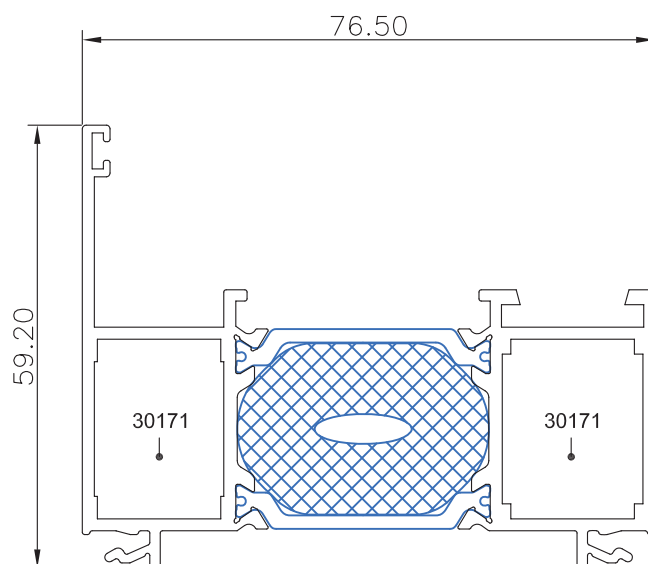

Ref. 2526

PRACTICABLE DOMO 77RT

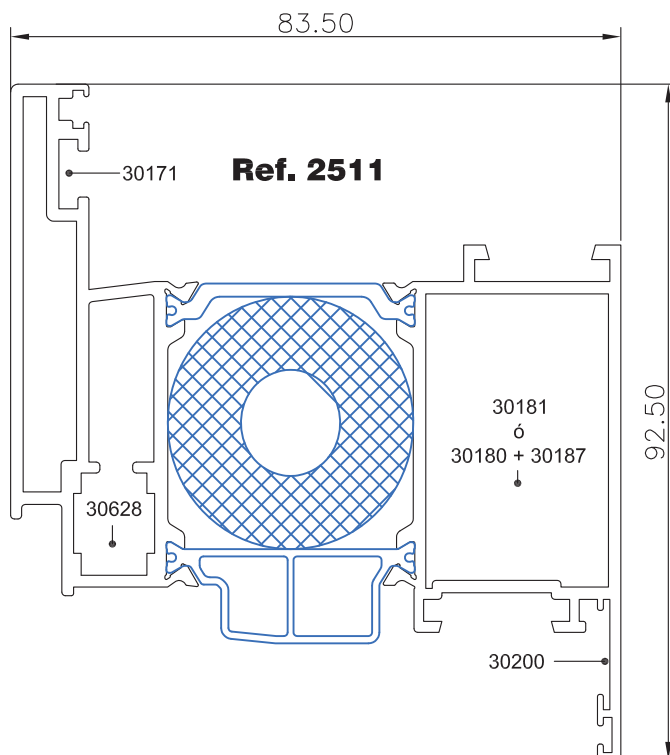
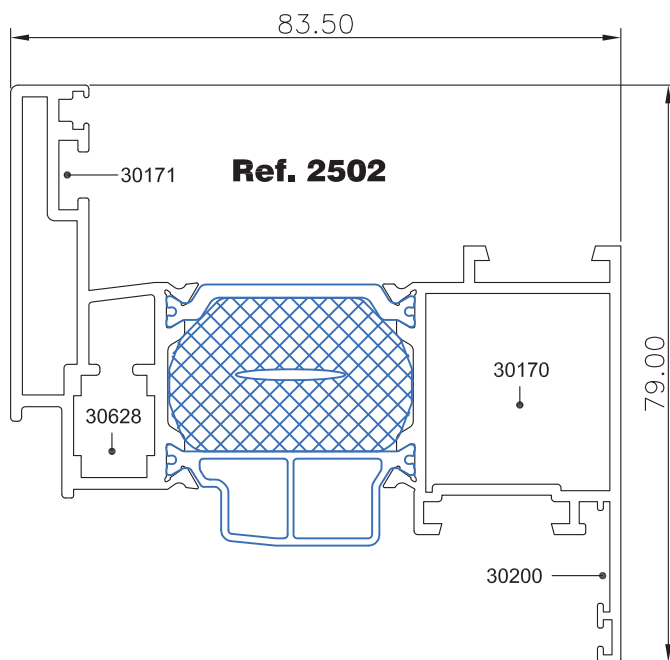

PRACTICABLE DOMO 77RT

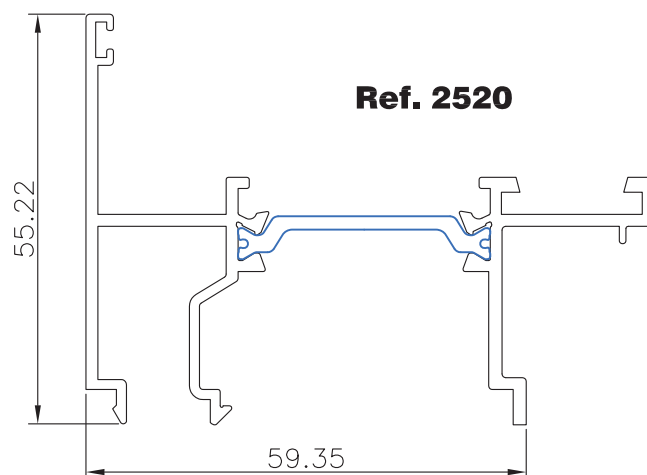
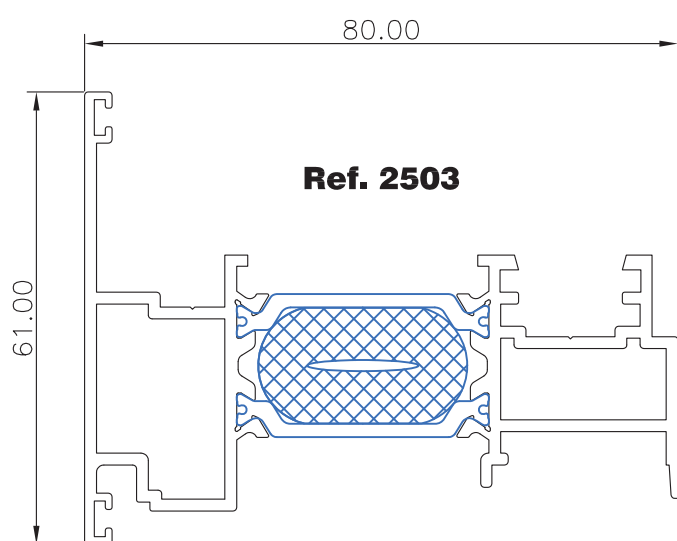
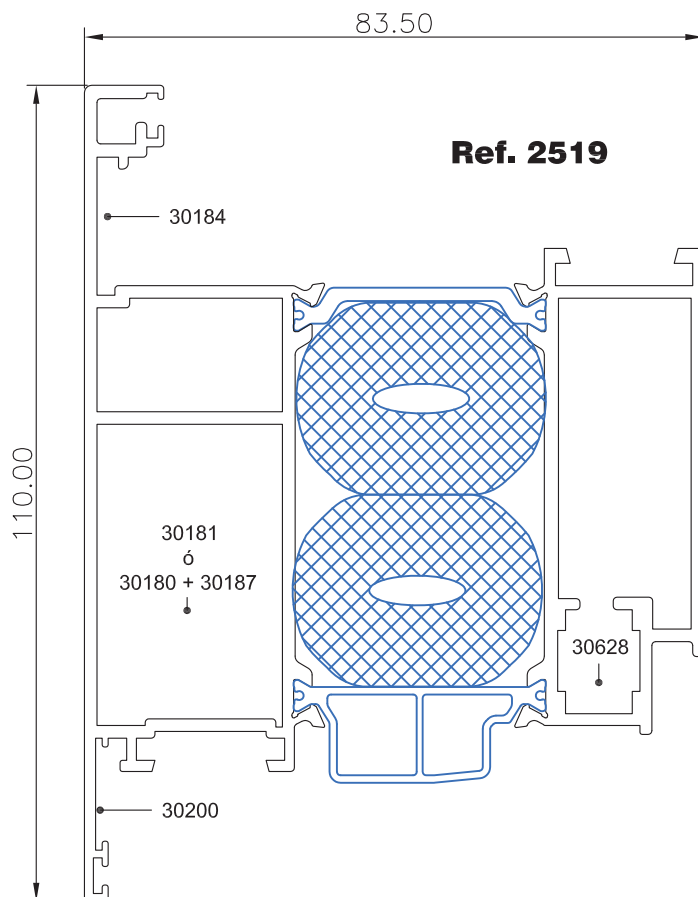

PRACTICABLE DOMO 77RT

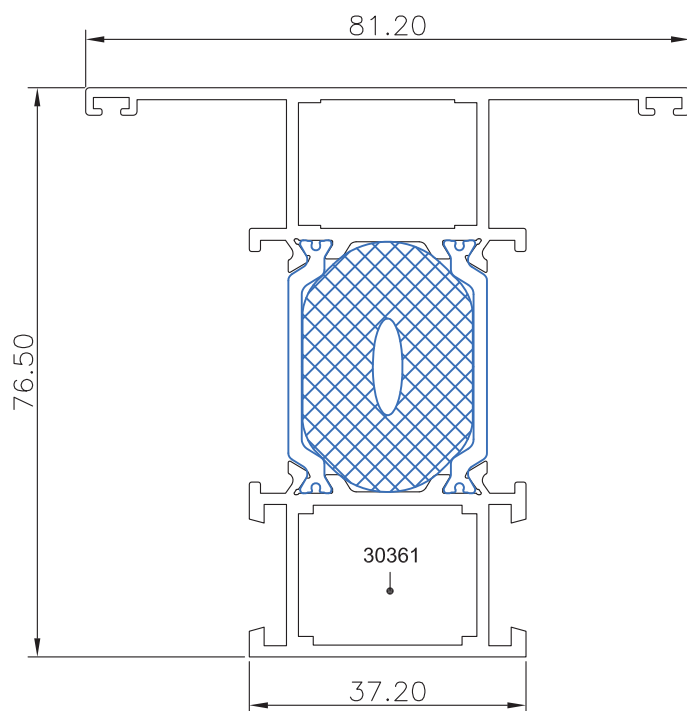

Ref. 2504

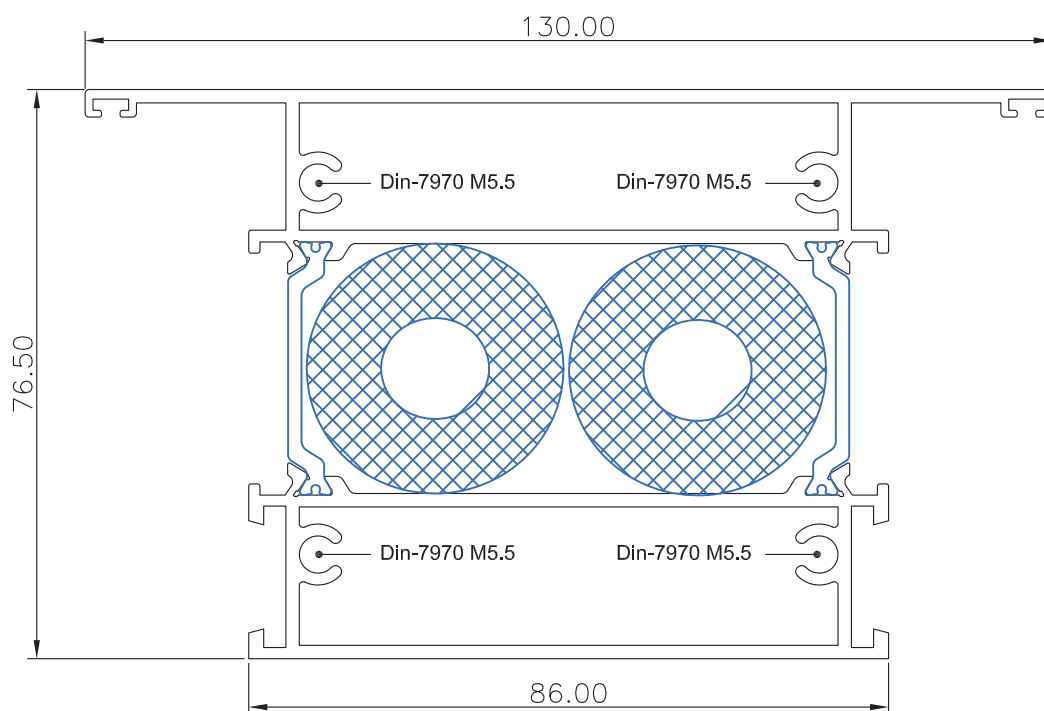

Ref. 2512

PRACTICABLE DOMO 77RT

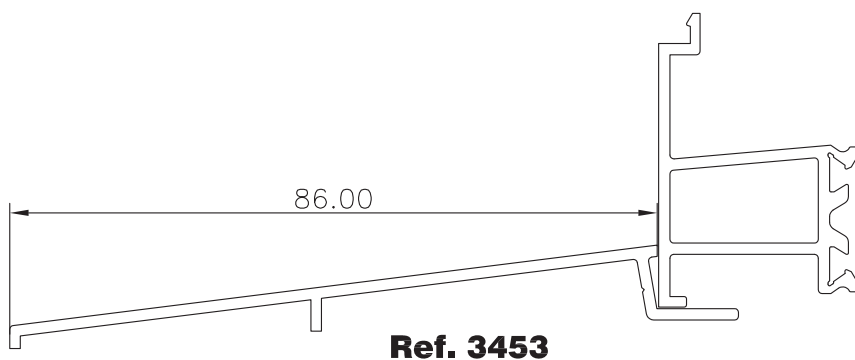
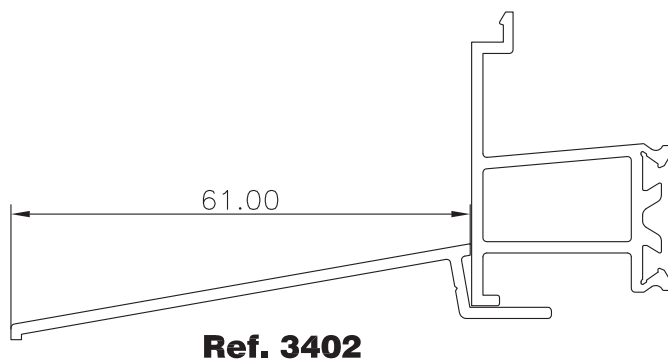
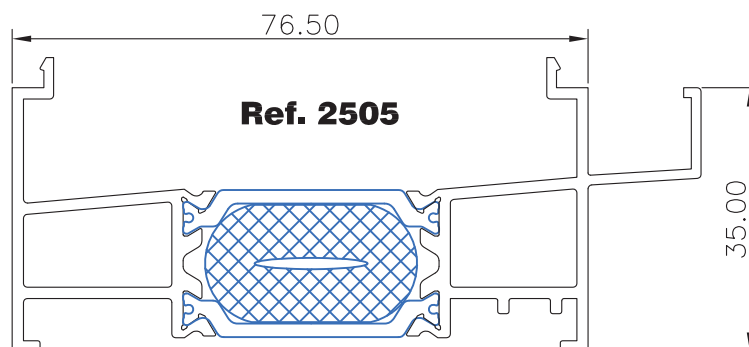



PRACTICABLE DOMO 77RT

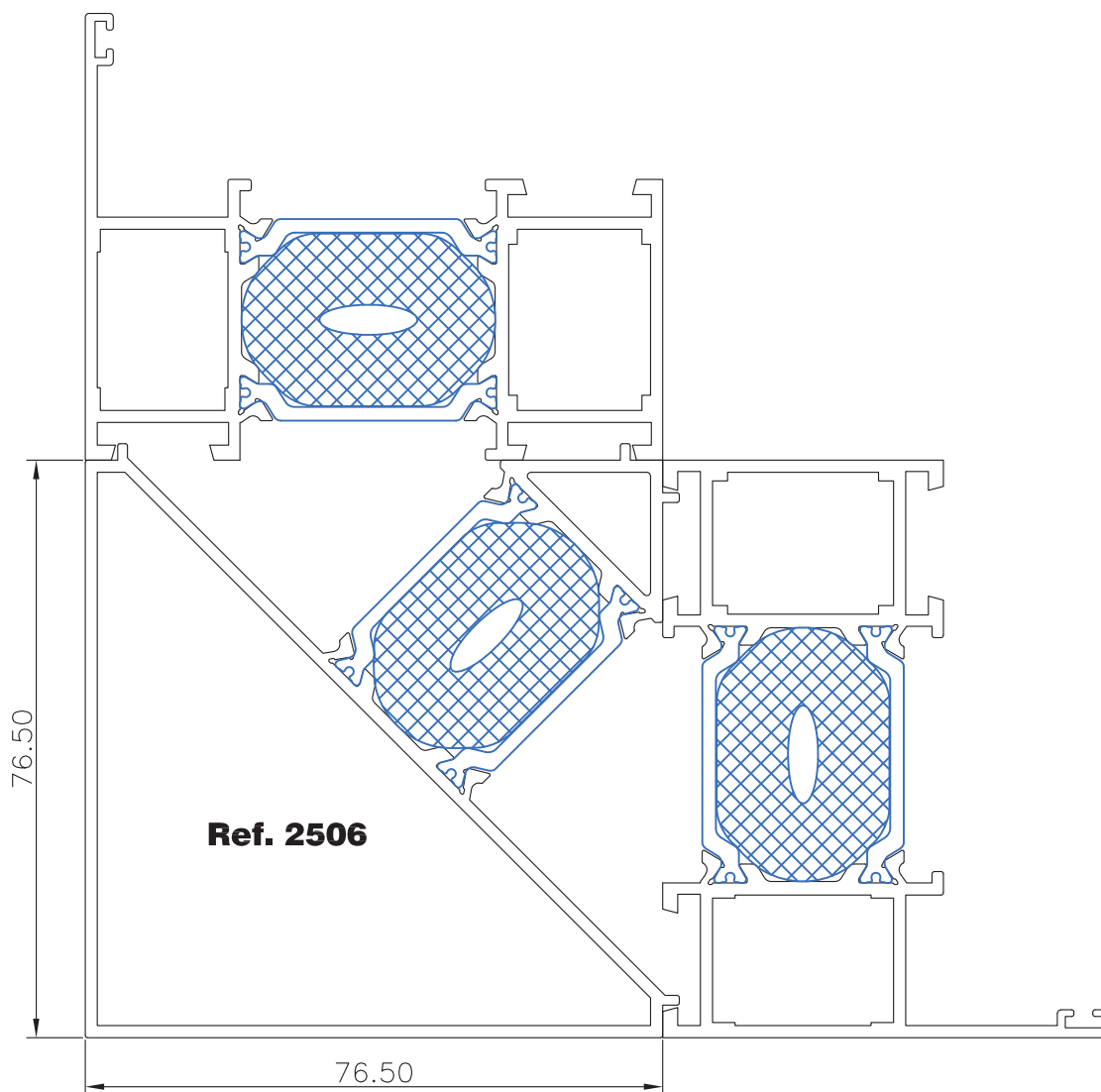

PRACTICABLE DOMO 77RT

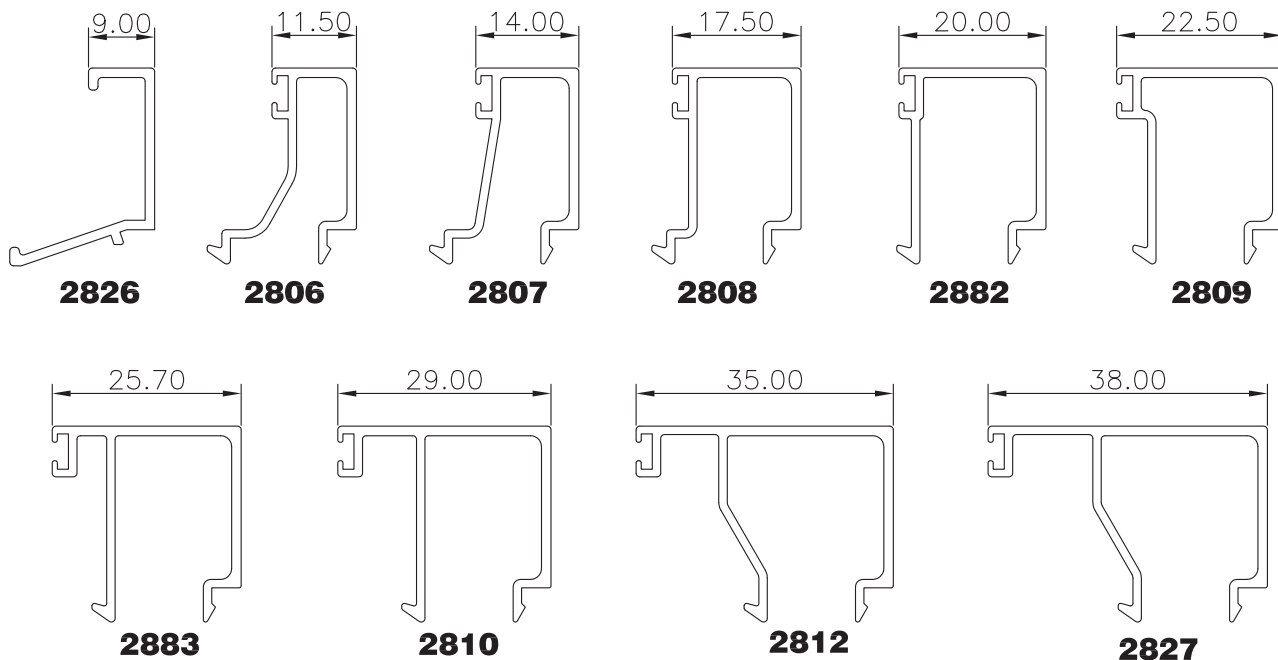





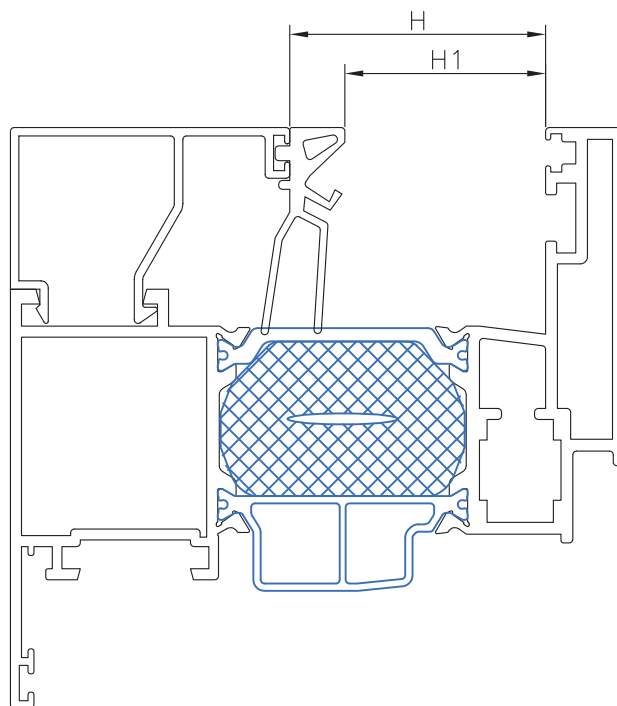



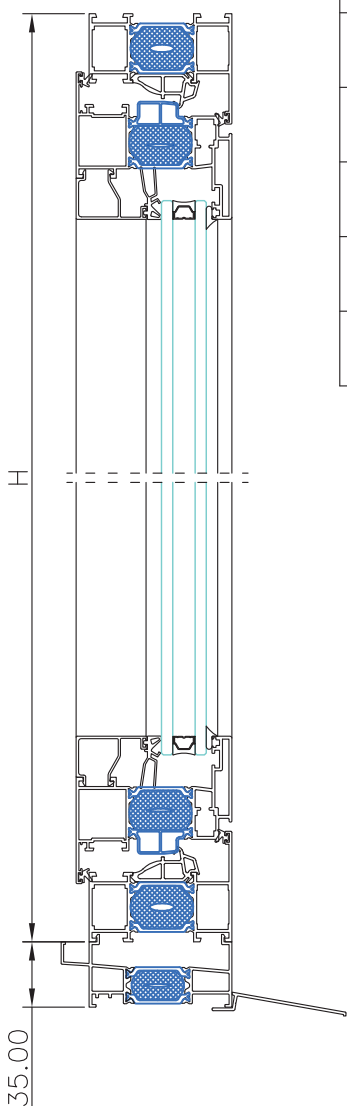
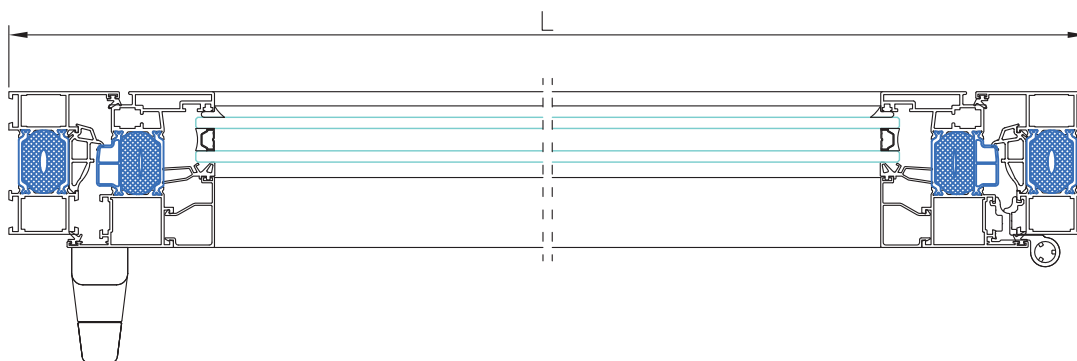



HUECOS LIBRES PARA ACRISTALAR

Referencia	H (mm)	H1 (mm)
2826 (9.0mm)	64.00	60.00
2806 (11.5mm)	61.00	57.00
2807 (14.0mm)	59.00	55.00
2808 (17.5mm)	55.00	50.00
2882 (20.0mm)	53.00	49.00
2809 (22.5mm)	50.00	46.00
2883 (25.7mm)	47.00	43.00
2810 (29.0mm)	44.00	40.00
2812 (35.0mm)	38.00	34.00
2827 (38.0mm)	35.00	31.00



PRACTICABLE DOMO 77RT



	Ref.	Descripción	Horizontal			Vertical		
			Corte	Cantidad	Medida	Corte	Cantidad	Medida
	2501	Marco ventana		2	L		2	H
	2502	Hoja ventana		2	L - 63		2	H - 63
	2505	Condensación		1	L			
	3402	Bandeja		1	L			
		Junquillos corte recto		4	L - 177		2	H - 221

Ref.	Descripción	Horizontal		Vertical	
		Cantidad	Medida	Cantidad	Medida
31052	Junta central	2	L	2	H
31041	Junta batiente (int.- ext.)	4	L	4	H
31066	Junta acristalamiento int.	2	L	2	H
31057	Angulo vulcanizado para j. central	4			



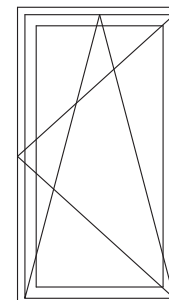



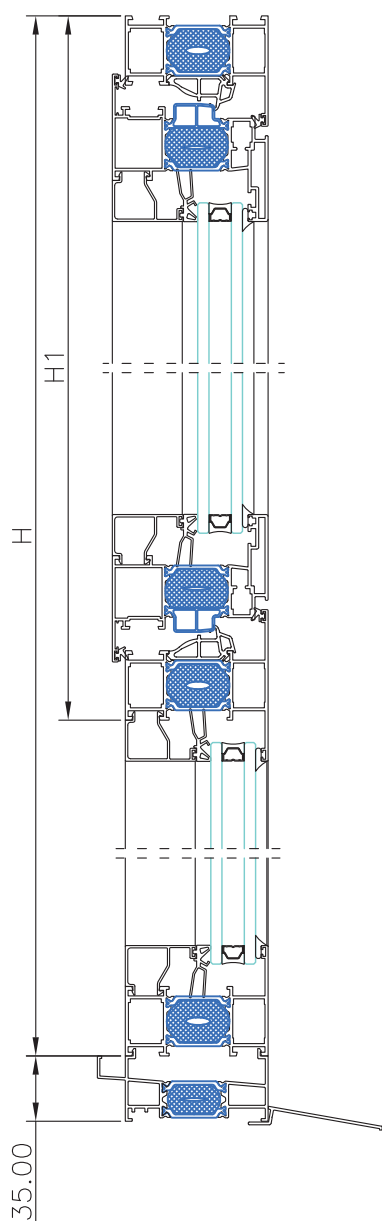
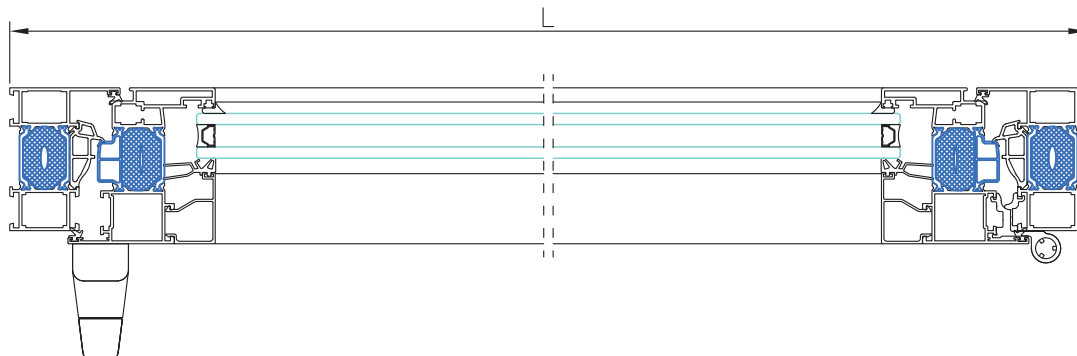

Ref.	Descripción	Cantidad
30171	Escuadra marco	8
30170	Escuadra hoja int.	4
30628	Escuadra hoja ext.	4
30195	Escuadra alineamiento ext. hoja	4
30200	Escuadra alineamiento int. hoja	4
30211	Juego tapas condensación	1
30371	Tapa salida de aguas	L/500
	Herraje	Ver tabla



PRACTICABLE DOMO 77RT

CREATIVOS



Ref.	Descripción	Horizontal			Vertical		
		Corte	Cantidad	Medida	Corte	Cantidad	Medida
2501	Marco ventana		2	L		2	H
2502	Hoja ventana		2	L - 63		2	H1 - 63
2504	Travesaño		1	L - 66			
2505	Condensación		1	L			
3402	Bandeja		1	L			
	Junquillos corte recto		2 2	L - 177 L - 74		2 2	H1 - 221 (H-H1) - 81

Ref.	Descripción	Horizontal		Vertical	
		Cantidad	Medida	Cantidad	Medida
31052	Junta central	2	L	2	H1
31041	Junta batiente (int.- ext.)	4	L	4	H1
31066	Junta acristalamiento int.	2	L	2	H1
31057	Angulo vulcanizado para j. central	4			



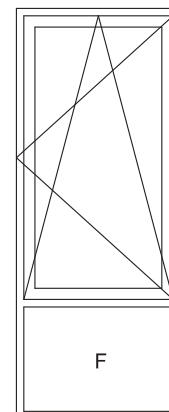





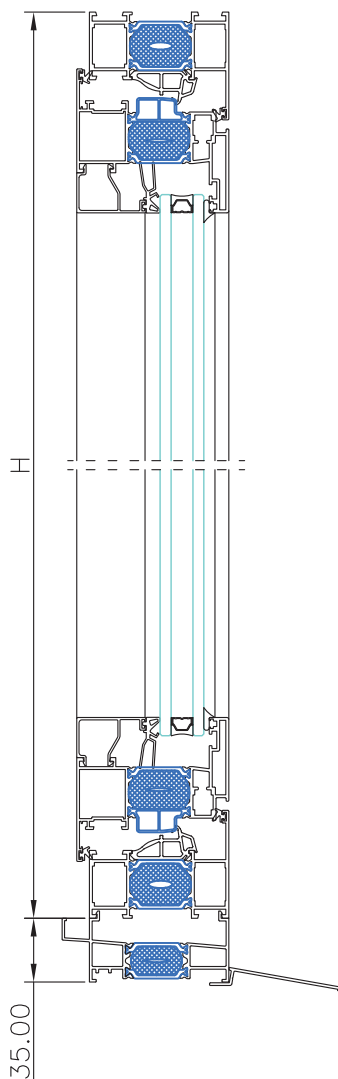
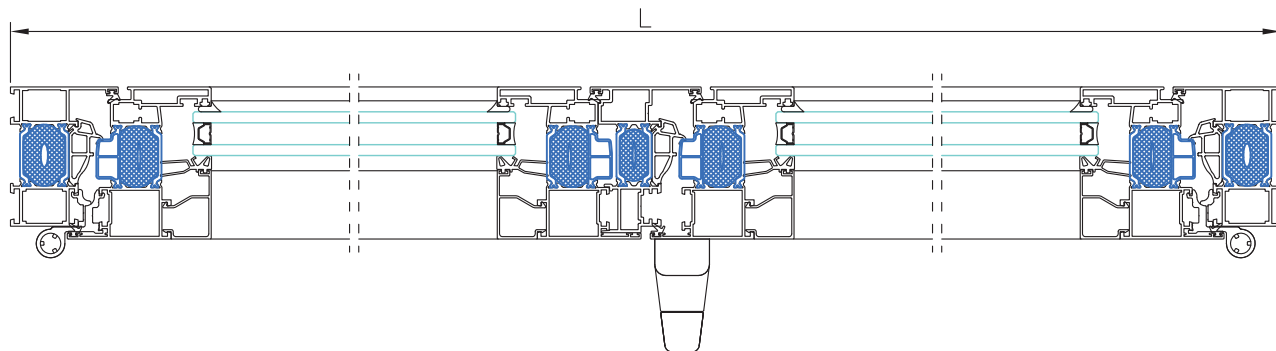





Ref.	Descripción	Cantidad
30171	Escuadra marco	8
30170	Escuadra hoja int.	4
30628	Escuadra hoja ext.	4
30195	Escuadra alineamiento ext. hoja	4
30200	Escuadra alineamiento int. hoja	4
30211	Juego tapas condensación	1
30371	Tapa salida de aguas	L/500
30631	Tope travesaño	2
	Herraje	Ver tabla



PRACTICABLE DOMO 77RT

CREATIVOS



	Ref.	Descripción	Horizontal			Vertical		
			Corte	Cantidad	Medida	Corte	Cantidad	Medida
	2501	Marco ventana		2	L		2	H
	2502	Hoja ventana		4	L/2 - 34		4	H - 63
	2503	Inversor					1	H - 129
	2505	Condensación		1	L			
	3402	Bandeja		1	L			
		Junquillos corte recto		4	L/2 - 148		4	H - 221





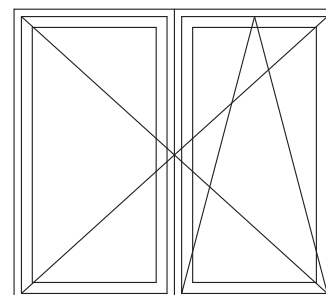



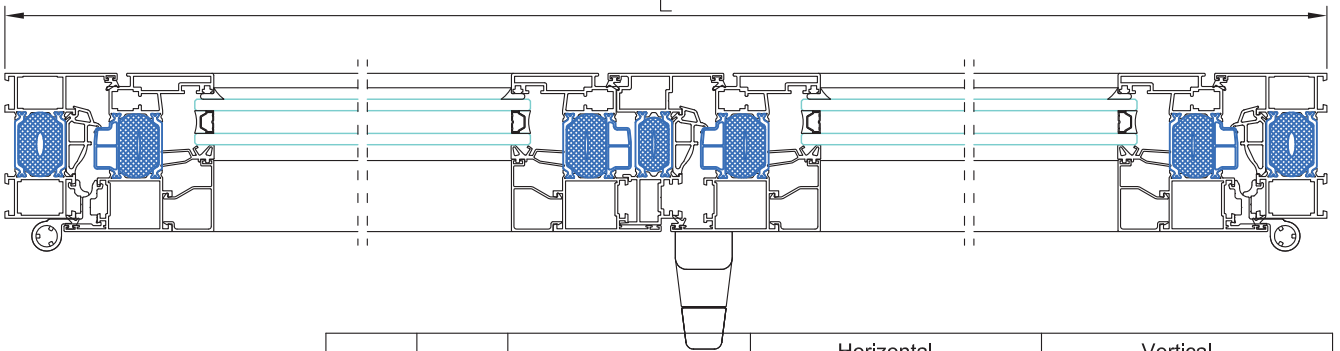







Ref.	Descripción	Horizontal		Vertical	
		Cantidad	Medida	Cantidad	Medida
31052	Junta central	2	L	3	H
31041	Junta batiente (int.- ext.)	4	L	8	H
31066	Junta acristalamiento int.	2	L	4	H
31057	Angulo vulcanizado para j. central	4			

Ref.	Descripción	Cantidad
30171	Escuadra marco	8
30170	Escuadra hoja int.	8
30628	Escuadra hoja ext.	8
30195	Escuadra alineamiento ext. hoja	8
30200	Escuadra alineamiento int. hoja	8
30463	Juego tapas inversor	1
30211	Juego tapas condensación	1
30371	Tapa salida de aguas	L/500
	Herraje	Ver tabla



PRACTICABLE DOMO 77RT



	Ref.	Descripción	Horizontal			Vertical		
			Corte	Cantidad	Medida	Corte	Cantidad	Medida
	2501	Marco ventana		2	L		2	H
	2502	Hoja ventana		4	L/2 - 34		4	H1 - 63
	2503	Inversor					1	H1 - 129
	2504	Travesaño		1	L - 66			
	2505	Condensación		1	L			
	3402	Bandeja		1	L			
		Junquillos corte recto		4	L/2 - 148		4	H1 - 221
				2	L - 74		2	(H-H1) - 81

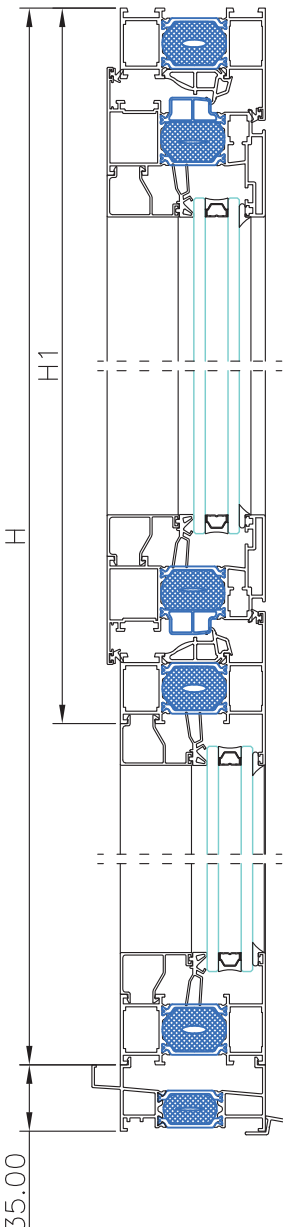

Ref.	Descripción	Horizontal		Vertical	
		Cantidad	Medida	Cantidad	Medida
31052	Junta central	2	L	3	H1
31041	Junta batiente (int.- ext.)	4	L	8	H1
31066	Junta acristalamiento int.	2	L	4	H1
31057	Angulo vulcanizado para j. central	4			

Ref.	Descripción	Cantidad
30171	Escuadra marco	8
30170	Escuadra hoja int.	8
30628	Escuadra hoja ext.	8
30195	Escuadra alineamiento ext. hoja	8
30200	Escuadra alineamiento int. hoja	8
30463	Juego tapas inversor	1
30211	Juego tapas condensación	1
30371	Tapa salida de aguas	L/500
30631	Tope travesaño	2
	Herraje	Ver tabla

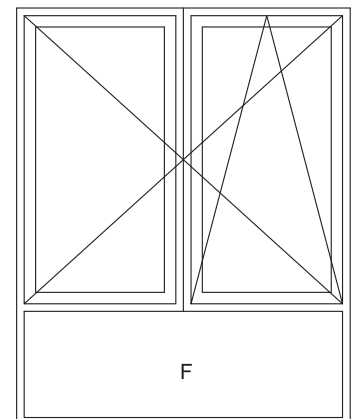







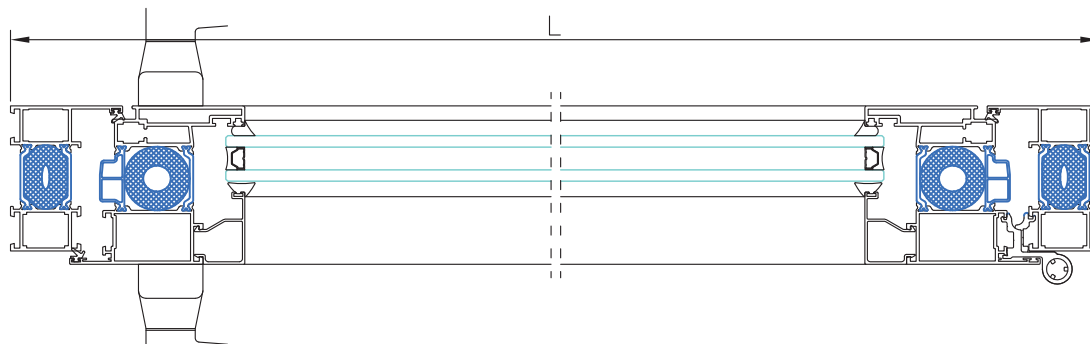





PRACTICABLE DOMO 77RT

SISTEMAS
CREATIVOS

Puerta 1 hoja apertura interior



	Ref.	Descripción	Horizontal			Vertical		
			Corte	Cantidad	Medida	Corte	Cantidad	Medida
	2501	Marco puerta		1	L		2	H + 50
	2511	Hoja recta puerta		1	L - 62		2	H - 36
	2512	Zócalo		1	L - 193			
		Junquillos corte inglete		2	L - 203		2	H - 215
		Junquillos corte recto		2	L - 203		2	H - 259

Ref.	Descripción	Horizontal		Vertical	
		Cantidad	Medida	Cantidad	Medida
31041	Junta batiente (int.- ext.)	2	L	4	H

Ref.	Descripción	Cantidad
30171	Escuadra marco puerta	4
30181	Escuadra hoja puerta	2
30628	Escuadra exterior hoja	2
30195	Escuadra alin. ext. hoja	2
30200	Escuadra alineamiento hoja	2
	Herraje	Ver tablas

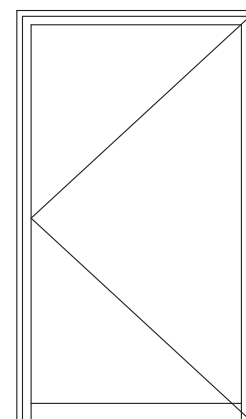







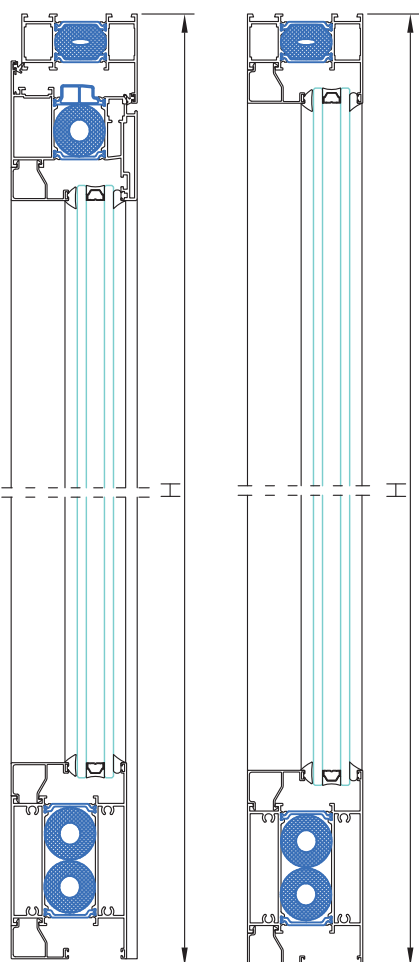
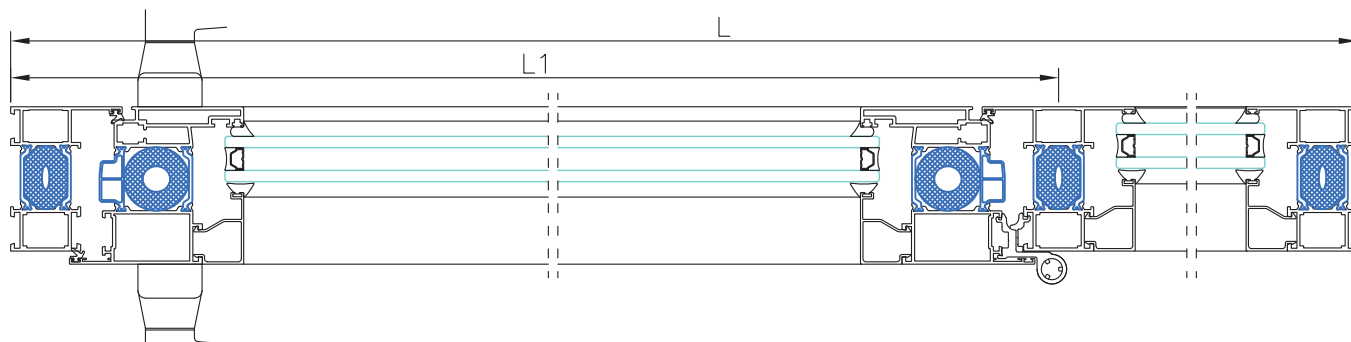



Ctra. Estación, s/n • 36720 GUILLAREI - TUI (Pontevedra)
Teléfono 986 607 133 • Fax 986 607 134

PRACTICABLE DOMO 77RT

Puerta 1 hoja apertura interior con fijo lateral



Ref.	Descripción	Horizontal			Vertical		
		Corte	Cantidad	Medida	Corte	Cantidad	Medida
2501	Marco puerta		1	L		2	H + 50
2511	Hoja recta puerta		2	L/1 - 44		2	H - 36
2504	Travesaño					1	H - 32
2512	Zócalo		1 1	L1 - 175 (L-L1) - 46			
	Junquillos corte inglete		2 2	L1 - 185 (L-L1) - 56		2 2	H - 215 H - 210
	Junquillos corte recto		2 2	L1 - 185 (L-L1) - 56		2 2	H - 259 H - 254

Ref.	Descripción	Horizontal		Vertical	
		Cantidad	Medida	Cantidad	Medida
31041	Junta batiente (int.- ext.)	4	L	4	H

Ref.	Descripción	Cantidad
30171	Escuadra marco puerta	4
30181	Escuadra hoja puerta	2
30628	Escuadra exterior hoja	2
30195	Escuadra alin. ext. hoja	2
30200	Escuadra alineamiento hoja	2
30631	Tope de travesaño	1
	Herraje	Ver tablas

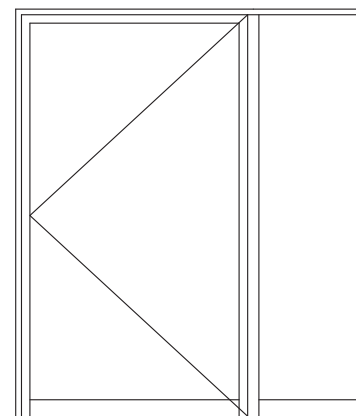







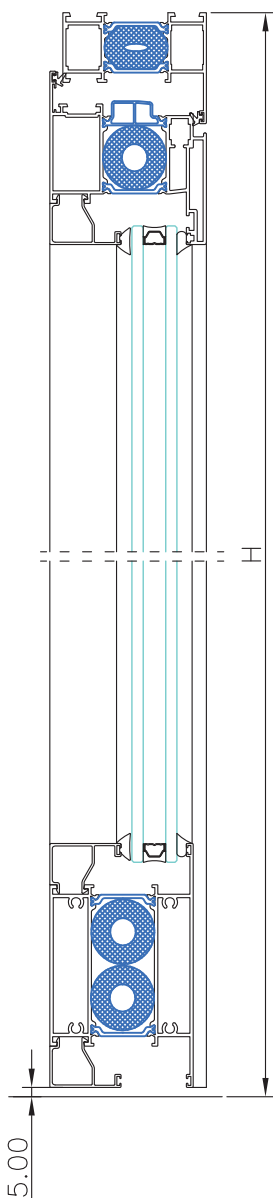
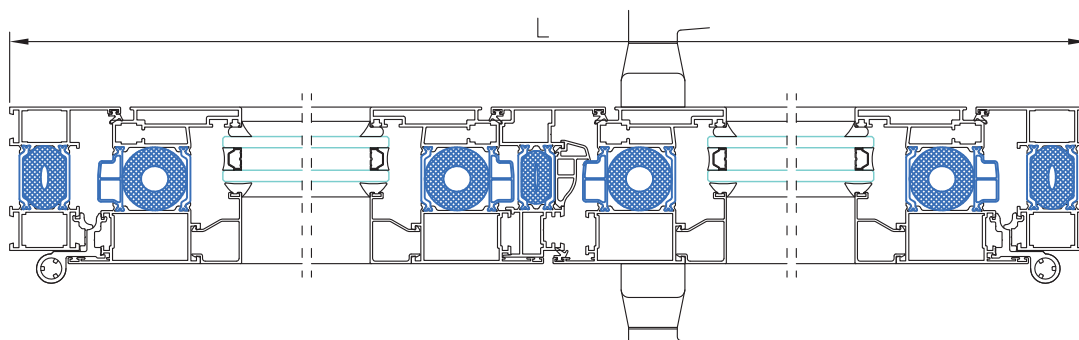







PRACTICABLE DOMO 77RT

Puerta 2 hojas apertura interior

CREATIVOS



	Ref.	Descripción	Horizontal			Vertical		
			Corte	Cantidad	Medida	Corte	Cantidad	Medida
	2501	Marco puerta		1	L		2	H + 50
	2511	Hoja recta puerta		2	L/2 - 34		4	H - 36
	2503	Inversor recto					1	H - 69
	2512	Zócalo		2	L/2 - 165			
		Junquillos corte inglete		4	L/2 - 170		4	H - 215
		Junquillos corte recto		2	L/2 - 170		4	H - 259

Ref.	Descripción	Horizontal		Vertical	
		Cantidad	Medida	Cantidad	Medida
31041	Junta batiente (int.- ext.)	4	L	12	H



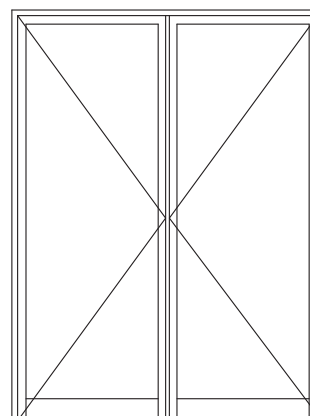





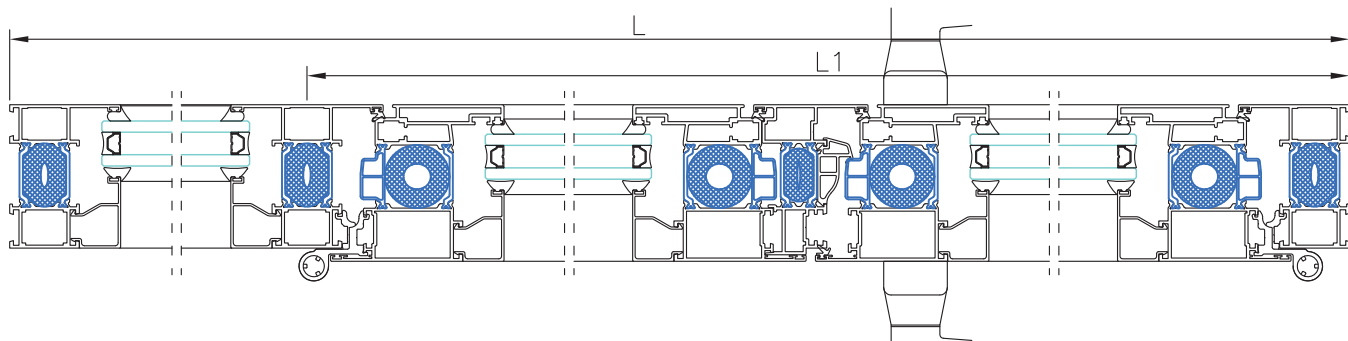

Ref.	Descripción	Cantidad
30171	Escuadra marco puerta	4
30181	Escuadra hoja puerta	4
30628	Escuadra exterior hoja	4
30195	Escuadra alin. ext. hoja	4
30200	Escuadra alineamiento hoja	4
30463	Juego tapas inversor	1
	Herraje	Ver tablas



PRACTICABLE DOMO 77RT

Puerta 2 hojas apertura interior con fijo lateral



Ref.	Descripción	Horizontal			Vertical		
		Corte	Cantidad	Medida	Corte	Cantidad	Medida
2501	Marco puerta		1	L		2	H + 50
2511	Hoja recta puerta		2	L1/2 - 24		4	H - 36
2503	Inversor recto					1	H - 69
2504	Travesaño					1	H - 32
2512	Zócalo		2	L1/2 - 155			
			1	(L-L1) - 46			
	Junquillos corte inglete		4	L1/2 - 165		4	H - 215
			2	(L-L1) - 56			2
	Junquillos corte recto		2	L1/2 - 165		4	H - 259
			2	(L-L1) - 56			2

Ref.	Descripción	Horizontal		Vertical	
		Cantidad	Medida	Cantidad	Medida
31041	Junta batiente (int.- ext.)	4	L	12	H



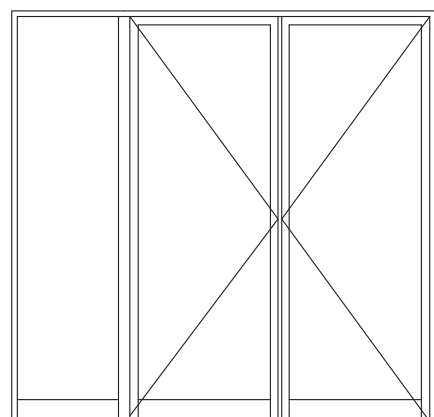





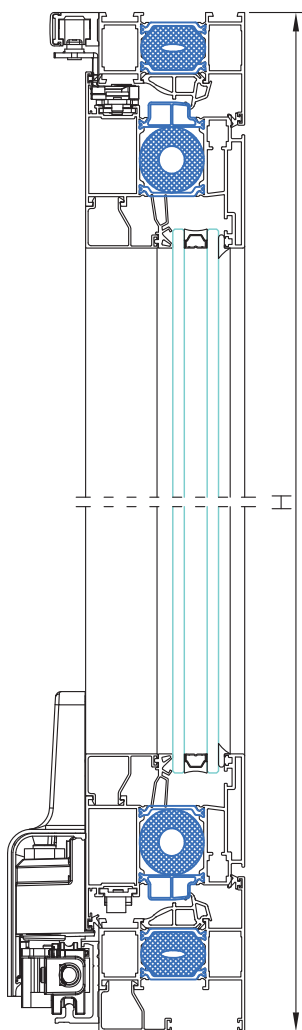
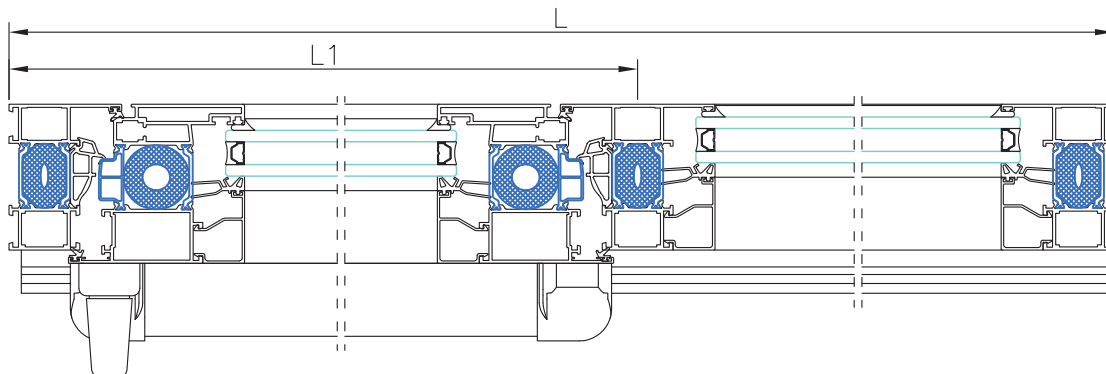



Ref.	Descripción	Cantidad
30171	Escuadra marco puerta	4
30181	Escuadra hoja puerta	4
30628	Escuadra exterior hoja	4
30195	Escuadra alin. ext. hoja	4
30200	Escuadra alineamiento hoja	4
30463	Juego tapas inversor	1
30631	Tope travesaño	1
	Herraje	Ver tablas



PRACTICABLE DOMO 77RT

PUERTA OSCILO-PARALELA



Ref.	Descripción	Horizontal			Vertical		
		Corte	Cantidad	Medida	Corte	Cantidad	Medida
2501	Marco ventana		1	L		2	H
2511	Hoja recta puerta		2	L1 - 44		2	H - 84
2504	Travesaño ventana		1	L - 64		1	H - 86
	Junquillos corte recto		2	L1 - 185		2	H - 269
			2	(L-L1) - 56		2	H - 140
			1	L - 74			

Ref.	Descripción	Horizontal		Vertical	
		Cantidad	Medida	Cantidad	Medida
31052	Junta central	2	L1	2	H
31041	Junta batiente (int.- ext.)	4	L1	4	H
31066	Junta acristalamiento int.	4	L1	4	H
31057	Angulo vulcanizado para j. central	4			



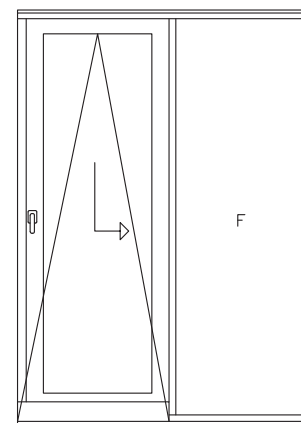





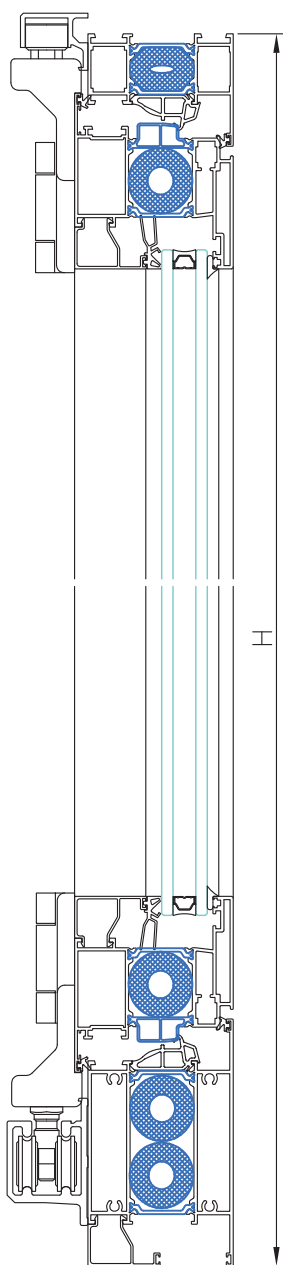
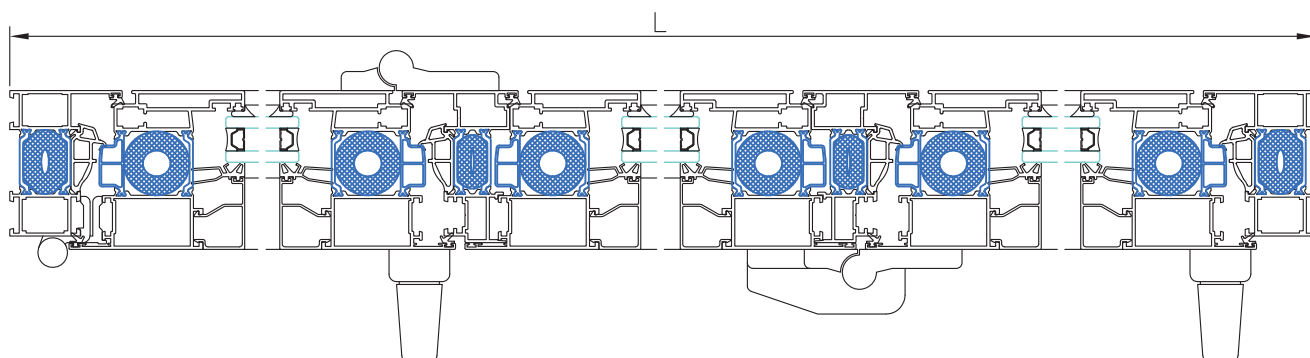





Ref.	Descripción	Pract.
30171	Escuadra marco	4
30181	Escuadra hoja int.	4
30628	Escuadra hoja ext.	4
30195	Escuadra alineamiento ext. hoja	4
30200	Escuadra alineamiento hoja	4
30631	Tope travesaño	4
30371	Tapa salida de aguas	L/500
	Herraje oscilo-paralela	Tabla



PRACTICABLE DOMO 77RT

Puerta Plegable 3 hojas



	Ref.	Descripción	Horizontal			Vertical		
			Corte	Cantidad	Medida	Corte	Cantidad	Medida
	2501	Marco puerta		1	L		2	H
	2511	Hoja recta puerta		6	Ver tabla		6	H - 133
	2503	Inversor recto					2	H - 203
	2512	Zócalo		1	L - 64			
		Junquillos corte inglete		6	L/3 - 165		6	H - 274
		Junquillos corte recto		6	L/3 - 165 L - 80		6	H - 318

Ref.	Descripción	Horizontal		Vertical	
		Cantidad	Medida	Cantidad	Medida
31052	Junta central	2	L	4	H
31041	Junta batiente (int.- ext.)	12	L	12	H
31066	Junta acristalamiento int.	2	L	6	H
31057	Angulo vulcanizado para j. central	4			

Ref.	Descripción	Pract.
31171	Escuadra marco puerta	2
30181	Escuadra hoja int.	12
30628	Escuadra hoja ext.	12
30195	Escuadra alineamiento ext. hoja	12
30200	Escuadra alineamiento int. hoja	12
30463	Juego tapas inversor	2
30371	Tapa salida de aguas	L/500
	Herraje plegable	Tabla

